

RECTIFIERS

Selenium Rectifier Stacks

Types SM & RM

DESCRIPTION

SenTerCel selenium stacks have been widely used for many years to provide H.T. supplies for domestic radio and television receivers.

The superiority of the selenium rectifier over all other devices is accepted in its ability to withstand heavy momentary overloads of current. In consequence the peak instantaneous current is virtually unlimited and large reservoir capacitors can be used for the best possible regulation and smoothing. The voltage drop is less than that of an equivalent thermionic valve and output voltages are therefore higher. There is, of course, a complete absence of fragile components so that failure cannot occur due to vibration or shock, an important consideration where portability is envisaged.

Two or more rectifiers can be connected in series when voltages higher than normal ratings are required and an assembly of two rectifiers, on a common spindle and bracket, is available in the radio stacks SMO/1 and SM2/3.

As the air temperature inside a radio or television receiver is considerably above room temperature, the rectifiers have been rated accordingly. Provided that simple precautions are taken to ensure adequate cooling by mounting the rectifier above an air vent or at least below any other heat-producing components, life and reliability are assured.

Graphs showing output characteristics for various combinations of input voltage, series resistance and reservoir capacitor are given on pages 6-15.

The table below gives obsolete types of rectifiers replaced by this range. The same fixing dimensions have been retained but the cross-section area is now slightly smaller.

Obsolete Type	Replacement Type
RM0	SM0/1
RM1	SM0/1
RM2	SM2/3
RM3	SM2/3
RM5	SM5
DRM1B	DSM0/1
DRM2B	DSM2/3
DRM3B	DSM2/3

Types SM & RM

CONTINUED

MAXIMUM RATINGS (Half-wave with reservoir capacitor)

Type	Mean Output Current (mA) at ambient temperature of		Input Voltage (V _{rms})	Peak Inverse Voltage (V)
	35°C	55°C		
SM0/1	60	30	125	350
SM2/3	120	90	125	350
DSM0/1	60	30	250**	700**
DSM2/3	120	90	250**	700**
RM4	250*	125	250	700
SM5	300*	150	250	700

* Up to 40°C ambient. ** Series connected.

CODING AND POLARITY MARKING

RECTIFIER MARKING		
Type	Code	Polarity
SM0/1	In Red Characters on the Positive End	A Red + on the Positive End
SM2/3	In Red Characters on the Positive End	A Red + on the Positive End
DSM0/1 DSM2/3	} In Black Characters on the Negative End	A Red band on each Positive Tag
RM4 SM5	} In Red Characters on the Positive End	A Red + on the Positive End

GENERAL INFORMATION

Ambient Temperature

The ambient temperature stated refers to the temperature of the air in which the rectifier is situated. As the air temperature inside a normally ventilated equipment may be considerably higher than the room temperature, a suitable allowance should be made.

Maximum Plate Temperature

The maximum temperature to which rectifiers may be allowed to rise is 75°C. Under no circumstances should this temperature be exceeded.

"Series Resistance"

It is recommended that a series resistor be connected between the a.c. input and the rectifier in order to reduce the peak current and to minimise any ageing which may take place. Recommended values of resistance are included in the regulation curves.

Ventilation and Mounting

Rectifiers must be mounted with the plates vertical and be provided with unrestricted ventilation, and should be placed so that they do not receive pre-heated air from other components.

Types SM & RM

CONTINUED

DIMENSIONS

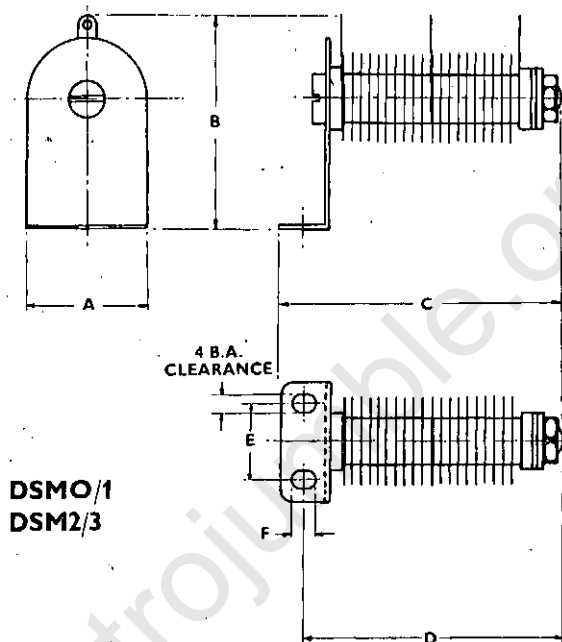

Nominal Dimensions	Type	DSM0/1		DSM2/3	
		in	cm	in	cm
A		1	2,54	$1\frac{3}{8}$	3,50
B		$1\frac{3}{4}$	4,45	$2\frac{3}{32}$	5,16
C		$2\frac{3}{8}$	6,04	$2\frac{7}{16}$	6,20
D		$2\frac{9}{16}$	5,56	$2\frac{1}{4}$	5,72
E		$\frac{5}{8}$	1,60	$\frac{5}{8}$	1,60
F		$\frac{1}{4}$	0,52	$\frac{1}{4}$	0,52

Types SM & RM

CONTINUED

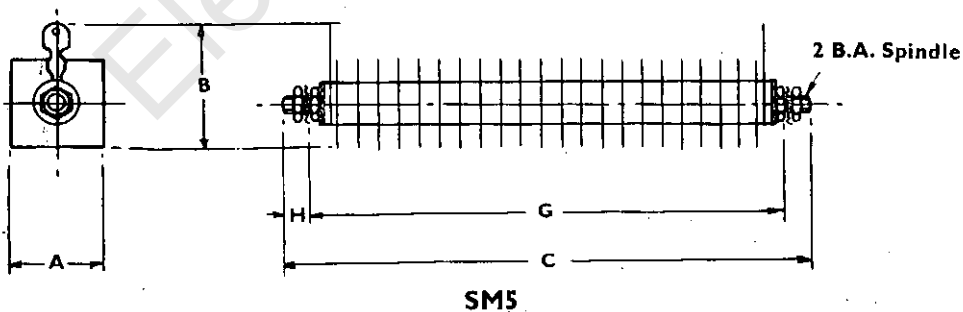
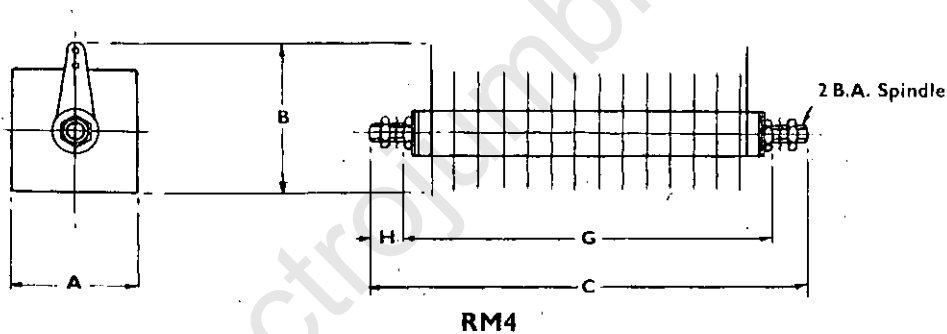
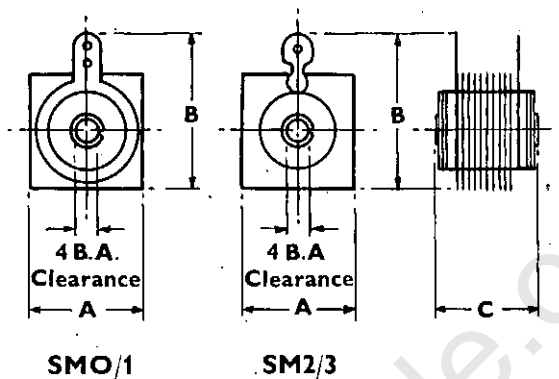

Types SM & RM

CONTINUED

TYPE	Nominal Dimensions						Maximum Dimensions			
	A		B		C		G		H	
	in	cm	in	cm	in	cm	in	cm	in	cm
SM0/1	$\frac{3}{8}$	1,84	1	2,54	$\frac{7}{8}$	2,24	—	—	—	—
SM2/3	1	2,54	$1\frac{1}{8}$	3,58	$\frac{7}{8}$	2,24	—	—	—	—
RM4	$1\frac{3}{8}$	3,50	$1\frac{1}{8}$	4,30	5	12,70	$4\frac{3}{8}$	10,88	$\frac{3}{16}$	0,80
SM5	1	2,54	$1\frac{3}{8}$	3,58	6	15,24	$5\frac{1}{8}$	13,90	$\frac{1}{4}$	0,64

WEIGHTS

Type	SM0/1	SM2/3	RM4	SM5	DSM0/1	DSM2/3
Ounces	1	$1\frac{1}{2}$	$4\frac{1}{2}$	$4\frac{1}{2}$	2	3
Grammes	28	42	126	126	56	98

Types SM & RM.

CONTINUED

SM/01

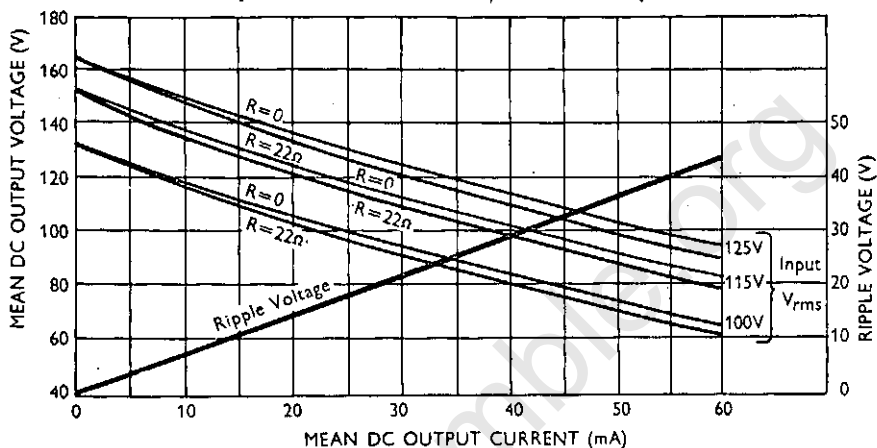
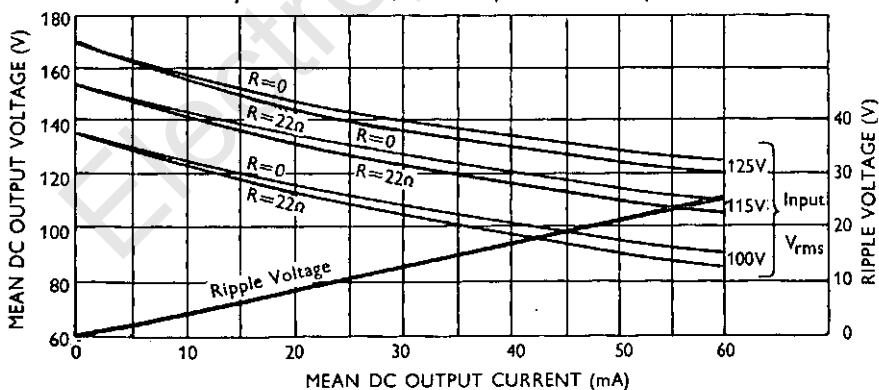
Output Characteristics with 8 μ F Reservoir CapacitorOutput Characteristics with 16 μ F Reservoir Capacitor

Types SM & RM

CONTINUED

SM2/3

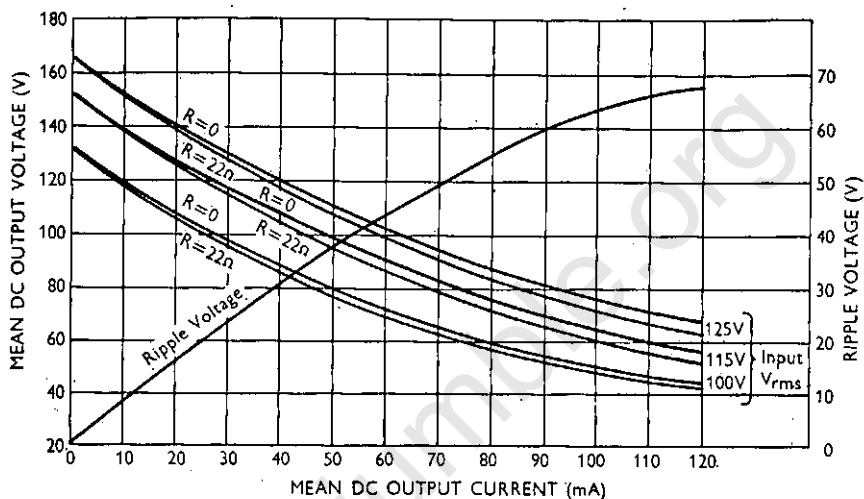
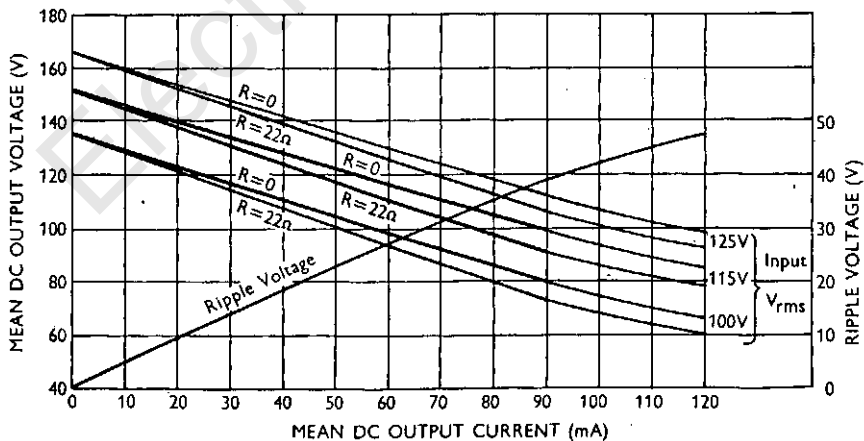
Output Characteristics with 8 μF Reservoir CapacitorOutput Characteristics with 16 μF Reservoir Capacitor

Types SM & RM

CONTINUED

DSM 0/1

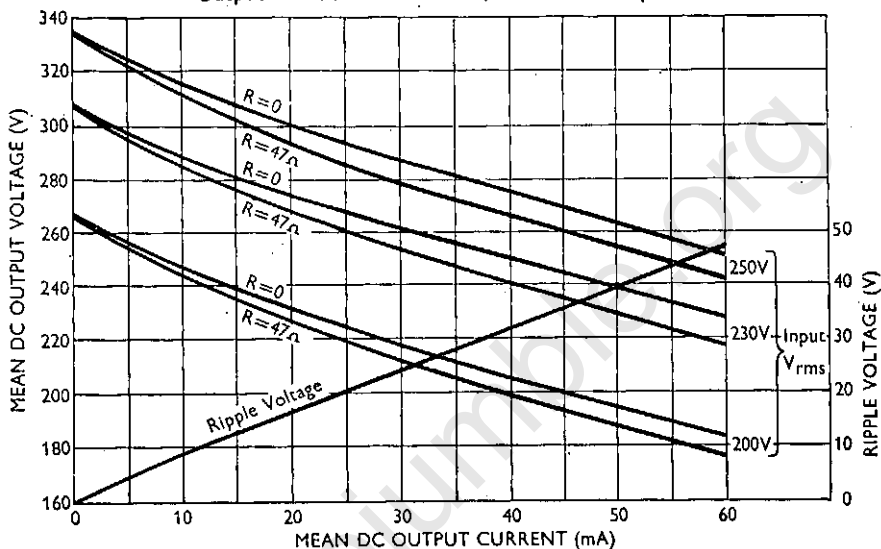
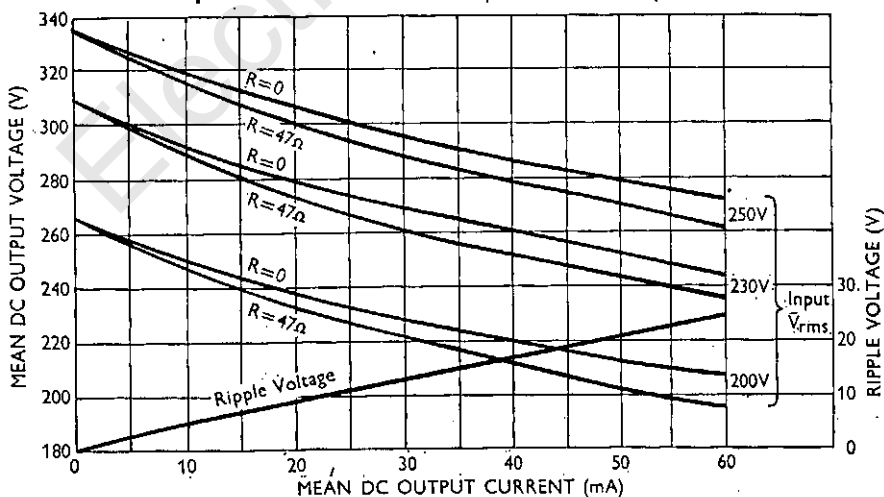
Output Characteristics with 8 μ F Reservoir CapacitorOutput Characteristics with 16 μ F Reservoir Capacitor

Types SM & RM

CONTINUED

DSM 2/3

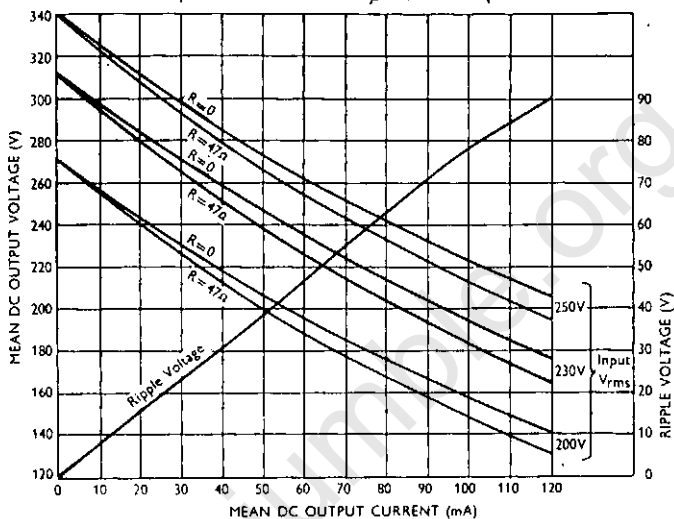
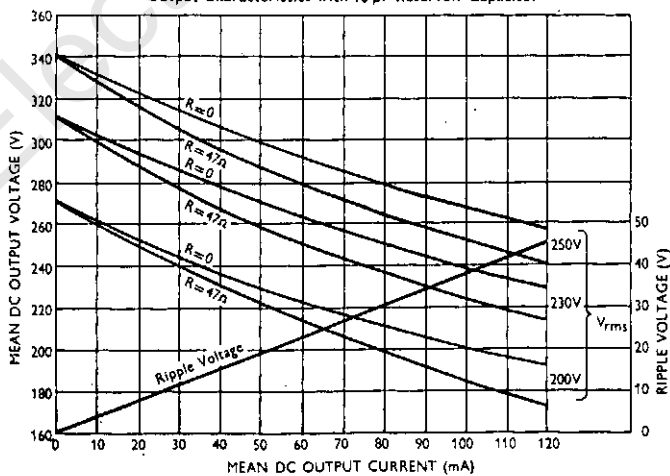
Output Characteristics with 8 μ F Reservoir CapacitorOutput Characteristics with 16 μ F Reservoir Capacitor

Types SM & RM

CONTINUED

RM4

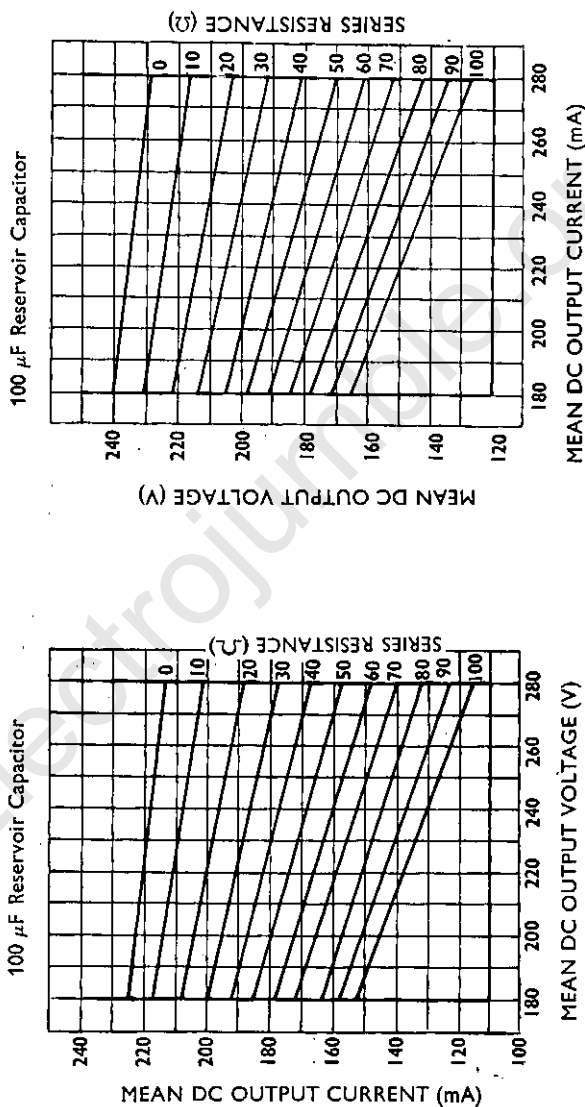
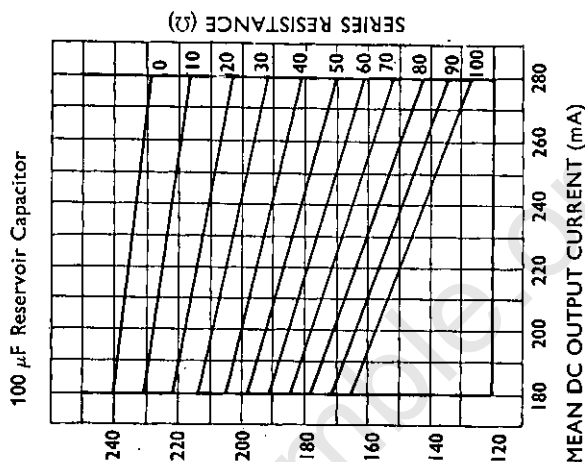
Output Characteristics with Input Voltage 200 V_{rms}Output Characteristics with Input Voltage 210 V_{rms}

Types SM & RM

CONTINUED

RM4

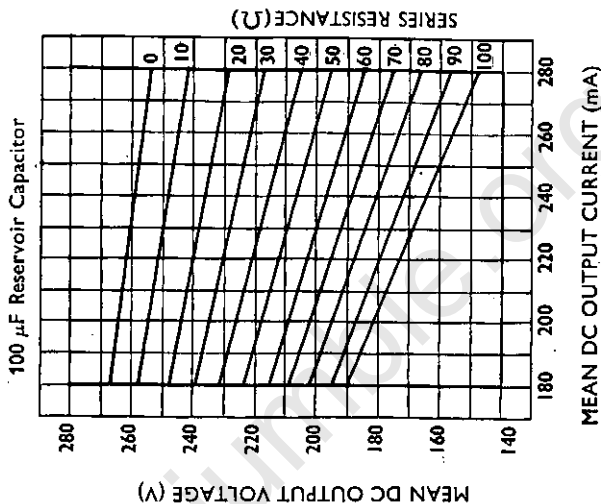
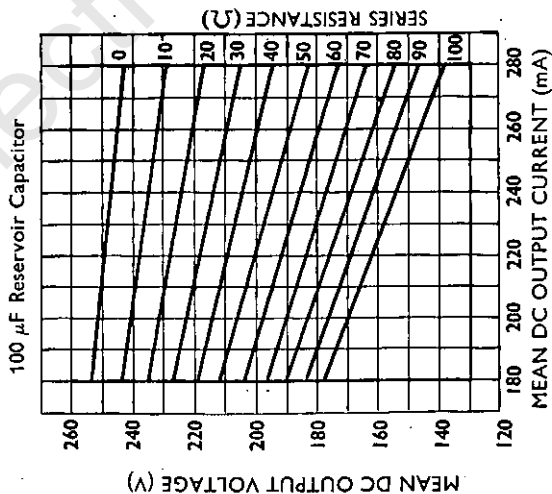
Output Characteristics with Input Voltage 230 V_{rms}Output Characteristics with Input Voltage 220 V_{rms}

Types SM & RM

CONTINUED

RM4

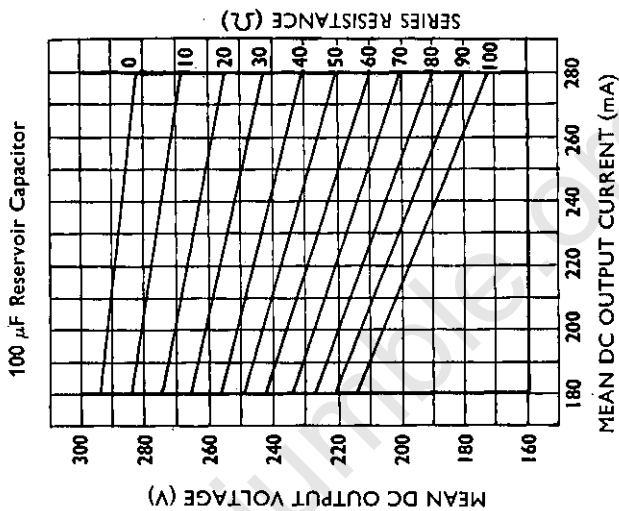
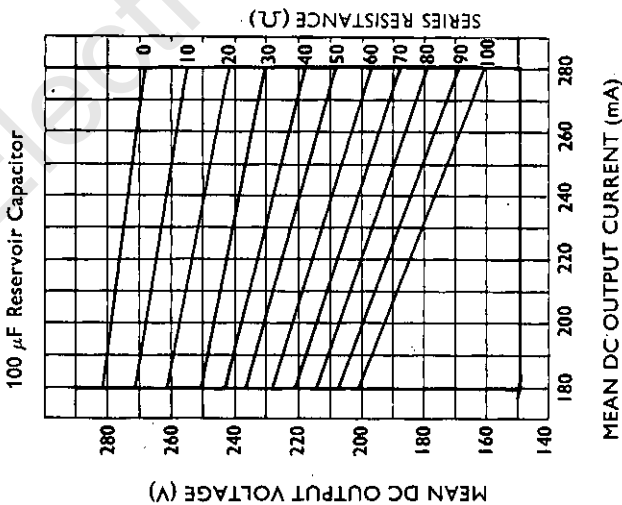
Output Characteristics with Input Voltage 250 V_{rms}Output Characteristics with Input Voltage 240 V_{rms}

Types SM & RM

CONTINUED

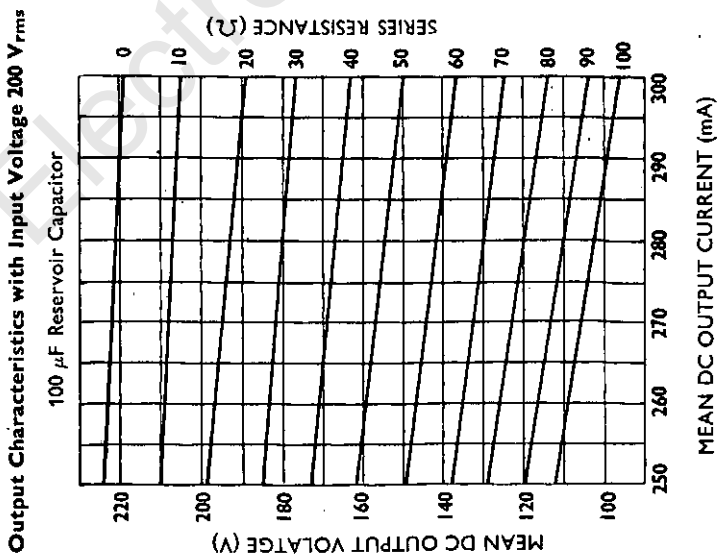
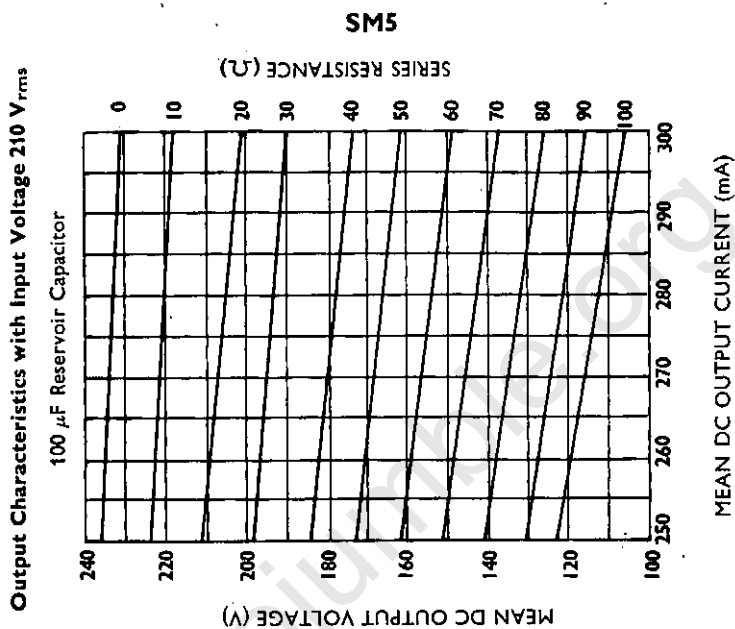

Types SM & RM

CONTINUED

SM5

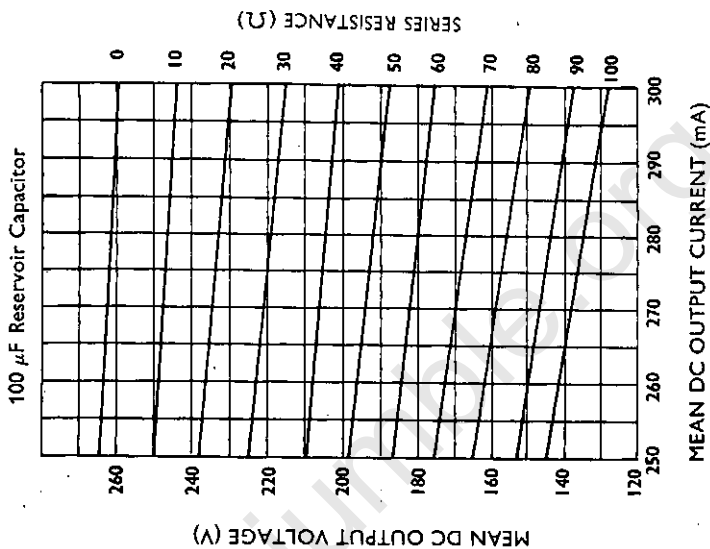
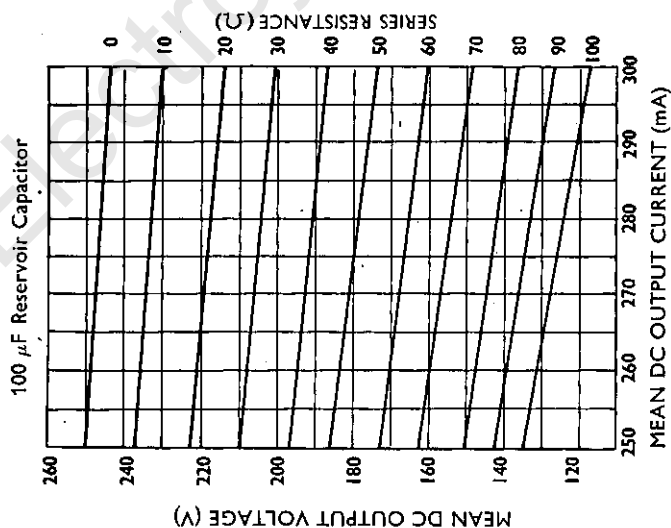
Output Characteristics with Input Voltage 230 V_{rms}Output Characteristics with Input Voltage 220 V_{rms}

Types SM & RM

CONTINUED

SM5

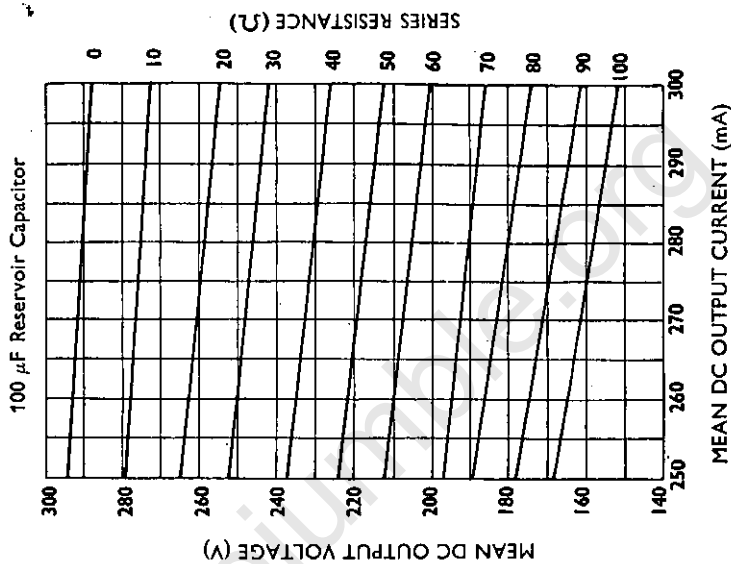
Output Characteristics with Input Voltage 250 V_{rms}Output Characteristics with Input Voltage 240 V_{rms}